

Applications of Random Networks

Complex Networks
CSYS/MATH 303, Spring, 2011

Analysis of real
networks

How to build revisited

Motifs

References

Prof. Peter Dodds

Department of Mathematics & Statistics
Center for Complex Systems
Vermont Advanced Computing Center
University of Vermont



Outline

Applications of
Random Networks

Analysis of real
networks

How to build revisited
Motifs

References

Analysis of real networks

How to build revisited
Motifs

References



More on building random networks

- ▶ **Problem:** How much of a real network's structure is non-random?
- ▶ Key elephant in the room: the **degree distribution** P_k .
- ▶ First observe **departure** of P_k from a Poisson distribution.
- ▶ **Next:** measure the departure of a real network with a **degree frequency** N_k from a random network with the same degree frequency.
- ▶ Degree frequency N_k = observed frequency of degrees for a real network.
- ▶ **What we now need to do:** Create an ensemble of random networks with degree frequency N_k and then compare.



Building random networks: Stubs

Phase 1:

- ▶ **Idea:** start with a soup of unconnected nodes with **stubs** (half-edges):

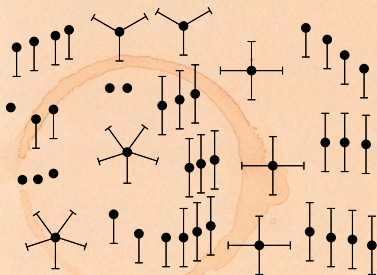
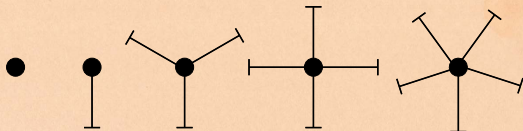

- ▶ Randomly select stubs (not nodes!) and connect them.
- ▶ Must have an even number of stubs.
- ▶ Initially allow **self-** and **repeat** connections.



Building random networks: First rewiring

Phase 2:

- ▶ Now find any (A) self-loops and (B) repeat edges and **randomly rewire** them.

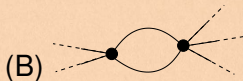
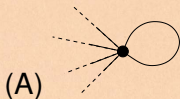

- ▶ **Being careful:** we can't change the degree of any node, so we can't simply move links around.
- ▶ **Simplest solution:** randomly rewire **two edges** at a time.



General random rewiring algorithm

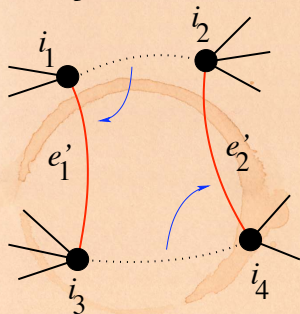
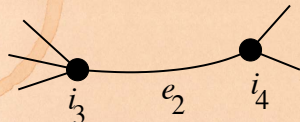
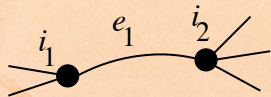

- ▶ Randomly choose **two edges**. (Or choose problem edge and a random edge)
- ▶ Check to make sure edges are **disjoint**.
- ▶ Rewire one end of each edge.
- ▶ Node degrees **do not change**.
- ▶ Works if e_1 is a self-loop or repeated edge.
- ▶ Same as finding on/off/on/off 4-cycles. and rotating them.



Sampling random networks

Phase 2:

- ▶ Use rewiring algorithm to remove all self and repeat loops.

Phase 3:

- ▶ **Randomize network** wiring by applying rewiring algorithm liberally.
- ▶ **Rule of thumb:** # Rewirings $\simeq 10 \times$ # edges^[1].



Random sampling

- ▶ **Problem** with only joining up stubs is **failure** to randomly sample from all possible networks.
- ▶ Example from Milo et al. (2003) [1]:

(a)

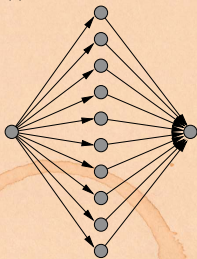

1 configuration

(b)

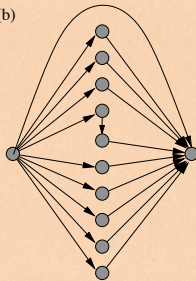

90 configurations

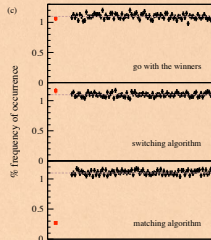

Sampling random networks

- ▶ What if we have P_k instead of N_k ?
- ▶ Must now create nodes before start of the construction algorithm.
- ▶ Generate N nodes by sampling from degree distribution P_k .
- ▶ Easy to do exactly numerically since k is discrete.
- ▶ **Note:** not all P_k will always give nodes that can be wired together.



- ▶ Idea of **motifs** ^[2] introduced by Shen-Orr, Alon et al. in 2002.
- ▶ Looked at gene expression within full context of **transcriptional regulation networks**.
- ▶ Specific example of Escherichia coli.
- ▶ Directed network with 577 interactions (edges) and 424 operons (nodes).
- ▶ Used network randomization to produce ensemble of alternate networks with same degree frequency N_k .
- ▶ Looked for **certain subnetworks (motifs)** that appeared more or less often than expected



Network motifs

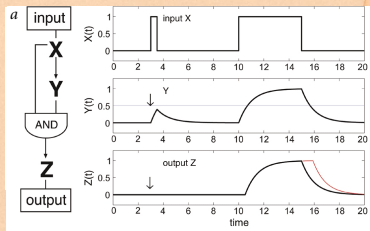
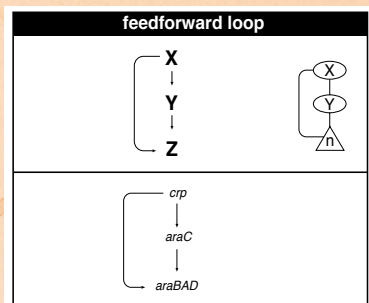

- ▶ Z only turns on in response to sustained activity in X.
- ▶ Turning off X rapidly turns off Z.
- ▶ Analogy to elevator doors.

Network motifs

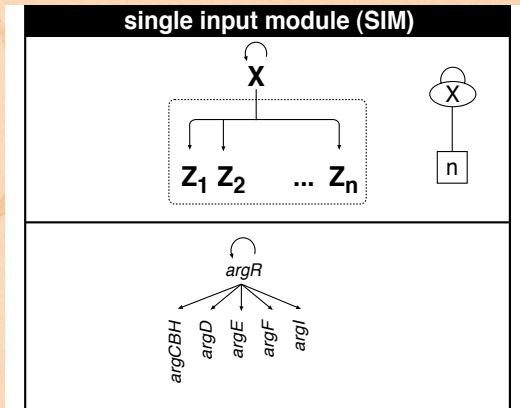

- ▶ Master switch.



Network motifs

dense overlapping regulons (DOR)

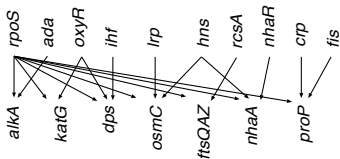
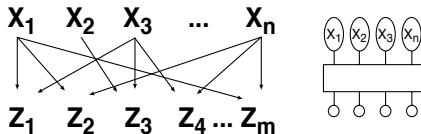

Network motifs

- ▶ Note: selection of motifs to test is reasonable but nevertheless ad-hoc.
- ▶ For more, see work carried out by Wiggins et al. at Columbia.



References I

- [1] R. Milo, N. Kashtan, S. Itzkovitz, M. E. J. Newman, and U. Alon.

On the uniform generation of random graphs with prescribed degree sequences, 2003. [pdf](#) (田)

- [2] S. S. Shen-Orr, R. Milo, S. Mangan, and U. Alon.

Network motifs in the transcriptional regulation network of *Escherichia coli*.

[Nature Genetics](#), pages 64–68, 2002. [pdf](#) (田)

