

Applications of Random Networks

Complex Networks, Course 303A, Spring, 2009

Prof. Peter Dodds

Department of Mathematics & Statistics
University of Vermont



Licensed under the *Creative Commons Attribution-NonCommercial-ShareAlike 3.0 License*.

Analysis of real
networks

How to build revisited
Motifs

References

Frame 1/17



Outline

Analysis of real
networks

How to build revisited
Motifs

References

Analysis of real networks

How to build revisited

Motifs

References

More on building random networks

- ▶ **Problem:** How much of a real network's structure is non-random?
- ▶ Key elephant in the room: the **degree distribution** P_k .
- ▶ First observe **departure** of P_k from a Poisson distribution.
- ▶ **Next:** measure the departure of a real network with a **degree frequency** N_k from a random network with the same degree frequency.
- ▶ Degree frequency N_k = observed frequency of degrees for a real network.
- ▶ **What we now need to do:** Create an ensemble of random networks with degree frequency N_k and then compare.

Analysis of real
networksHow to build revisited
Motifs

References

Building random networks: Stubs

Phase 1:

- ▶ **Idea:** start with a soup of unconnected nodes with **stubs** (half-edges):

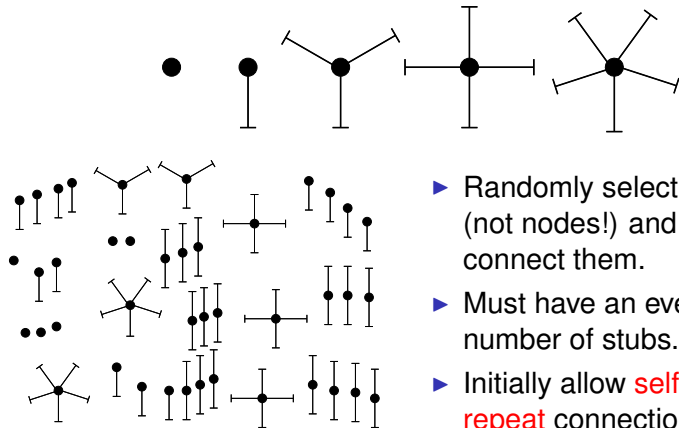

- ▶ Randomly select stubs (not nodes!) and connect them.
- ▶ Must have an even number of stubs.
- ▶ Initially allow **self-** and **repeat** connections.

Building random networks: First rewiring

Phase 2:

- ▶ Now find any (A) self-loops and (B) repeat edges and **randomly rewire** them.

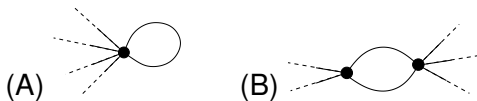

- ▶ **Being careful:** we can't change the degree of any node, so we can't simply move links around.
- ▶ **Simplest solution:** randomly rewire **two edges** at a time.

General random rewiring algorithm

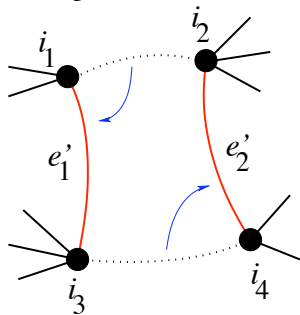
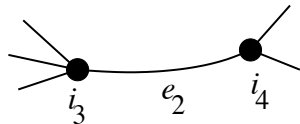
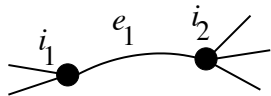

- ▶ Randomly choose **two edges**. (Or choose problem edge and a random edge)
- ▶ Check to make sure edges are **disjoint**.
- ▶ Rewire one end of each edge.
- ▶ Node degrees **do not change**.
- ▶ Works if e_1 is a self-loop or repeated edge.
- ▶ Same as finding on/off/on/off 4-cycles. and rotating them.

Analysis of real
networksHow to build revisited
Motifs

References

Sampling random networks

Phase 2:

- ▶ Use rewiring algorithm to remove all self and repeat loops.

Phase 3:

- ▶ **Randomize network** wiring by applying rewiring algorithm liberally.
- ▶ **Rule of thumb:** # Rewirings $\simeq 10 \times$ # edges^[1].

- ▶ **Problem** with only joining up stubs is **failure** to randomly sample from all possible networks.
- ▶ Example from Milo et al. (2003) [1]:

(a)

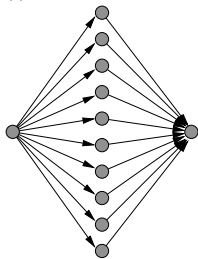

1 configuration

(b)

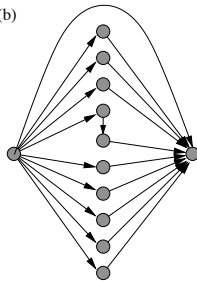

90 configurations

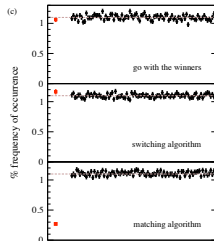

- ▶ What if we have P_k instead of N_k ?
- ▶ Must now create nodes before start of the construction algorithm.
- ▶ Generate N nodes by sampling from degree distribution P_k .
- ▶ Easy to do exactly numerically since k is discrete.
- ▶ **Note:** not all P_k will always give nodes that can be wired together.

Network motifs

Analysis of real
networksHow to build revisited
Motifs

References

- ▶ Idea of **motifs** ^[2] introduced by Shen-Orr, Alon et al. in 2002.
- ▶ Looked at gene expression within full context of **transcriptional regulation networks**.
- ▶ Specific example of Escherichia coli.
- ▶ Directed network with 577 interactions (edges) and 424 operons (nodes).
- ▶ Used network randomization to produce ensemble of alternate networks with same degree frequency N_k .
- ▶ Looked for **certain subnetworks** (**motifs**) that appeared more or less often than expected

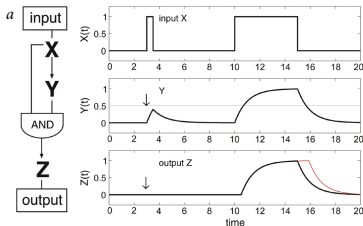
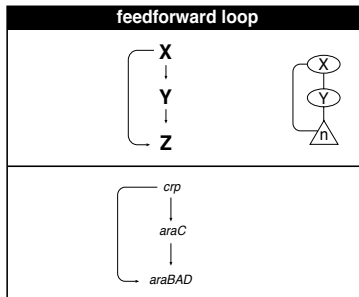

- ▶ Z only turns on in response to sustained activity in X .
- ▶ Turning off X rapidly turns off Z .
- ▶ Analogy to elevator doors.

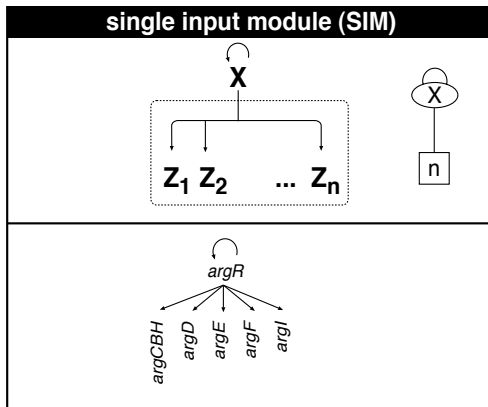

- ▶ Master switch.

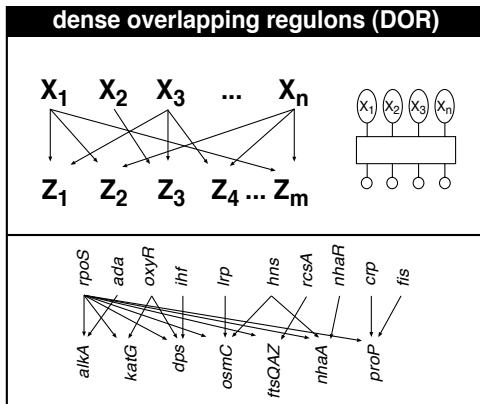

- ▶ Note: selection of motifs to test is reasonable but nevertheless ad-hoc.
- ▶ For more, see work carried out by Wiggins et al. at Columbia.

References I

-  [1] R. Milo, N. Kashtan, S. Itzkovitz, M. E. J. Newman, and U. Alon.

On the uniform generation of random graphs with prescribed degree sequences, 2003. [pdf](#) (⊞)

-  [2] S. S. Shen-Orr, R. Milo, S. Mangan, and U. Alon.
Network motifs in the transcriptional regulation network of *Escherichia coli*.

Nature Genetics, pages 64–68, 2002. [pdf](#) (⊞)